

New



FEATURES

1. Best space savings in its class.
2. Large capacity switching despite small size. Can replace micro ISO terminal type relays.
3. Terminals for PC board pattern designs are easily allocated.
4. Sealed type

TYPICAL APPLICATIONS

Haed lamp, Fog lamp, Fan motor, EPS, Defogger, Seat heater, etc.

Compliance with RoHS Directive

ORDERING INFORMATION

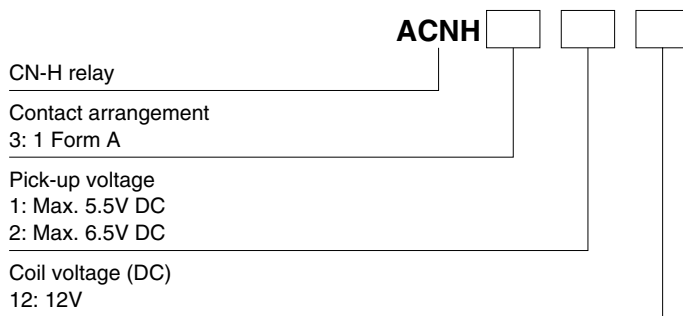

TYPES

Contact arrangement	Nominal coil voltage	Pick-up voltage (at 20°C 68°F)	Part No.
1 Form A	12V DC	Max. 6.5 V DC (Initial)	ACNH3212
		Max. 5.5 V DC (Initial)	ACNH3112

Standard packing; Carton (tube): 50 pcs.; Case: 1,000 pcs.

RATING

1. Coil data

Nominal coil voltage	Pick-up voltage (at 20°C 68°F)	Drop-out voltage (at 20°C 68°F)	Nominal operating current [$\pm 10\%$] (at 20°C 68°F)	Coil resistance [$\pm 10\%$] (at 20°C 68°F)	Nominal operating power (at 20°C 68°F)	Usable voltage range
12 V DC	Max. 6.5 V DC (Initial)	Min. 1.0 V DC (Initial)	37.5 mA	320 Ω	450 mW	10 to 16 V DC
	Max. 5.5 V DC (Initial)	Min. 0.8 V DC (Initial)	53.3 mA	225 Ω	640 mW	

CN-H (ACNH3)

2. Specifications

Characteristics	Item	Specifications	
Contact	Arrangement	1 Form A	
	Initial contact resistance (Initial)	Typ5mΩ (By voltage drop 6 V DC 1 A)	
	Contact material	Ag alloy (Cadmium free)	
Rating	Nominal switching capacity (resistive load)	30A 14V DC	
	Max. carrying current	<450mW> 35A/1 h, 45A/2 min. at 20°C 68°F 30A/1 h, 40A/2 min. at 85°C 185°F 25A/1 h, 35A/2 min. at 110°C 230°F	
		<640mW> 30A/1 h, 40A/2 min. at 20°C 68°F 25A/1 h, 35A/2 min. at 85°C 185°F 20A/1 h, 30A/2 min. at 110°C 230°F	
		Continuous carrying current	20A 14V DC (450mW) at 110°C 230°F
	Nominal operating power	450 mW (for pick-up voltage max. 6.5 V DC), 640 mW (for pick-up voltage max. 5.5 V DC)	
Min. switching capacity (resistive load)	1A 12V DC		
Electrical characteristics	Insulation resistance (Initial)	Min. 100 MΩ (at 500 V DC)	
	Breakdown voltage (Initial)	Between open contacts	500 Vrms for 1 min. (Detection current: 10mA)
		Between contacts and coil	500 Vrms for 1 min. (Detection current: 10mA)
	Operate time (at nominal voltage)	Max. 10ms (at 20°C 68°F, excluding contact bounce time) (Initial)	
Release time (at nominal voltage)	Max. 10ms (at 20°C 68°F) (Initial) (without diode)		
Mechanical characteristics	Shock resistance	Functional	Min. 100 m/s ² {10G} (Half-wave pulse of sine wave: 11ms; detection: 10μs)
		Destructive	Min. 1,000 m/s ² {100G} (Half-wave pulse of sine wave: 6ms)
	Vibration resistance	Functional	10 Hz to 100 Hz, Min. 44.1m/s ² {4.5G} (Detection time: 10μs)
		Destructive	10 Hz to 500 Hz, Min. 44.1m/s ² {4.5G} Time of vibration for each direction; X, Y direction: 2 hours, Z direction: 4 hours
Expected life	Mechanical	Min. 10 ⁷ (at 120 cpm)	
	Electrical	<Resistive load> Min. 10 ⁵ (At nominal switching capacity, operating frequency: 1s ON, 1s OFF) <Motor load> Min. 3×10 ⁵ : at 84 A (inrush), 18 A (steady), 14 V DC (Operating frequency: 2s ON, 5s OFF) <Lamp load> Min. 2×10 ⁵ : at 84 A (inrush), 12 A (steady), 14 V DC (Operating frequency: 1s ON, 14s OFF)	
Conditions	Conditions for operation, transport and storage	Ambient temp: -40°C to +110°C -40°F to +230°F Humidity: 2% R.H. to 85% R.H. (Not freezing and condensing at low temperature)	
Unit weight		Approx. 9 g .32 oz	

REFERENCE DATA

1-(1). Coil temperature rise

Sample: ACNH3212, 3pcs
Measured portion: Inside the coil
Contact carrying current: 10A, 20A, 30A
Ambient temperature: 25°C 77°F

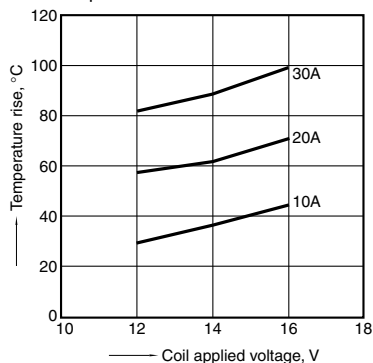

1-(2). Coil temperature rise

Sample: ACNH3212, 3pcs
Measured portion: Inside the coil
Contact carrying current: 10A, 20A
Ambient temperature: 110°C 230°F

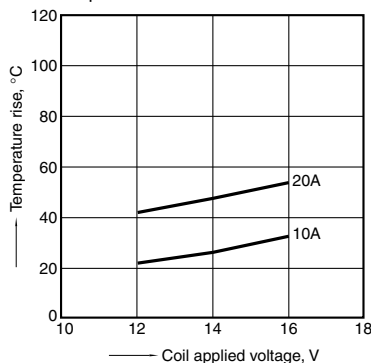

2. Ambient temperature and operating voltage range

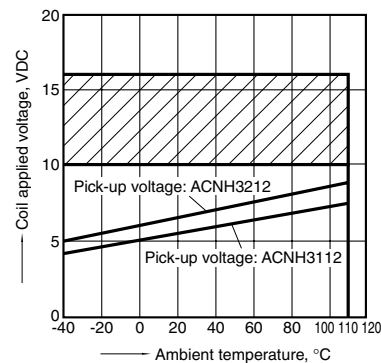

3-(1). Distribution of pick-up and drop-out voltage

Sample: ACNH3212, 20pcs.

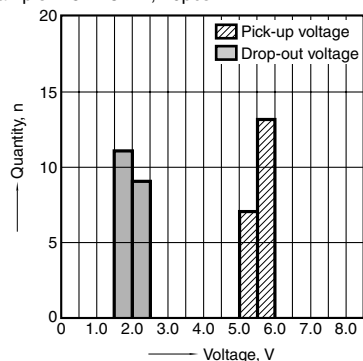

3-(2). Distribution of pick-up and drop-out voltage

Sample: ACNH3112, 20pcs.

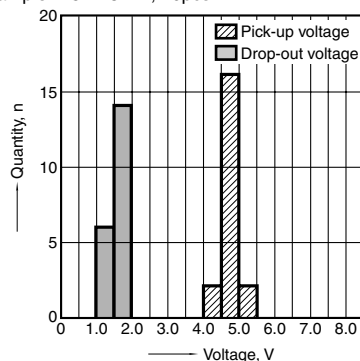

4-(1). Distribution of operate and release time
Sample: ACNH3212, 20pcs.

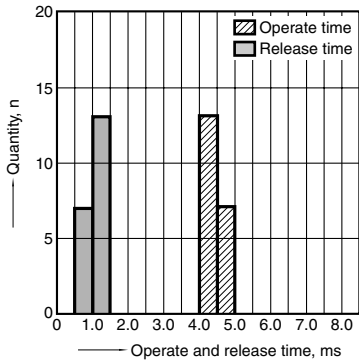

4-(2). Distribution of operate and release time
Sample: ACNH3112, 20pcs.

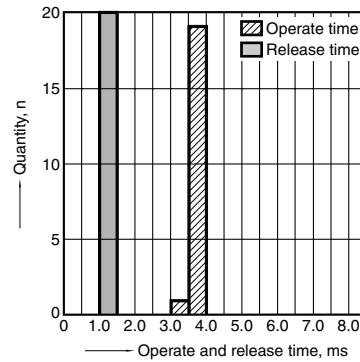

5. Electrical life test (Resistive load)

Sample: ACNH3212, 6pcs.
Load: Resistive load (NO side: 30A 14V DC)
Operating frequency: (ON:OFF = 1s:1s)
Ambient temperature: Room temperature

Circuit:

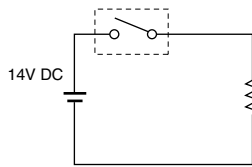

Change of pick-up and drop-out voltage

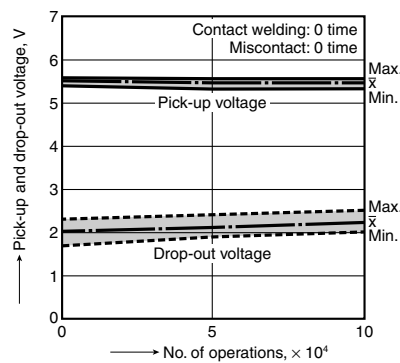

Change of contact resistance

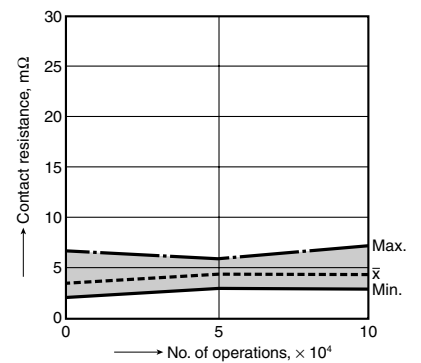

6-(1). Electrical life test (Motor load)

Sample: ACNH3212, 3pcs.
Load: inrush: 84A/steady: 18A, radiator fan actual load (motor free)
Switching frequency: (ON:OFF = 2s:5s)
Ambient temperature: 110°C 230°F

Circuit:

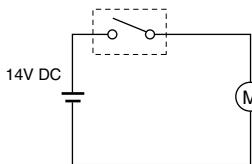

Change of pick-up and drop-out voltage

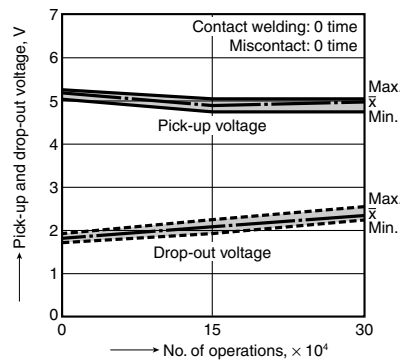

Change of contact resistance

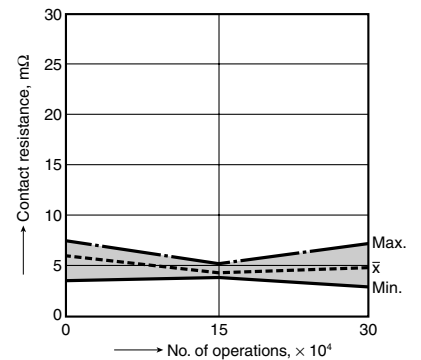

6-(2). Electrical life test (Lamp load)

Sample: ACNH3212, 6pcs.
Load: 60W×2, inrush: 84A/steady: 12A
Switching frequency: (ON:OFF = 1s:14s)
Ambient temperature: Room temperature

Circuit:

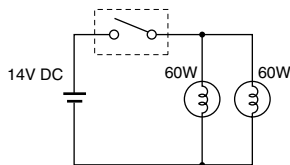

Change of pick-up and drop-out voltage

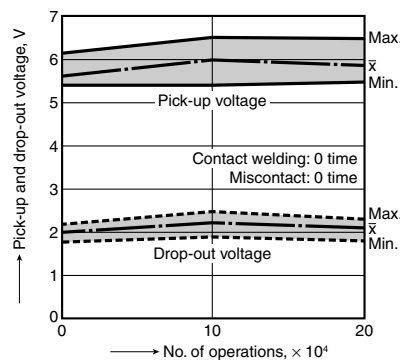

Change of contact resistance

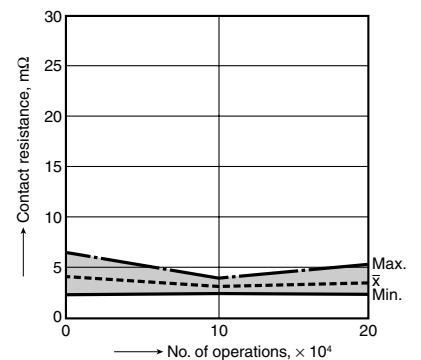

CN-H (ACNH3)

DIMENSIONS (Unit: mm inch)



External dimensions

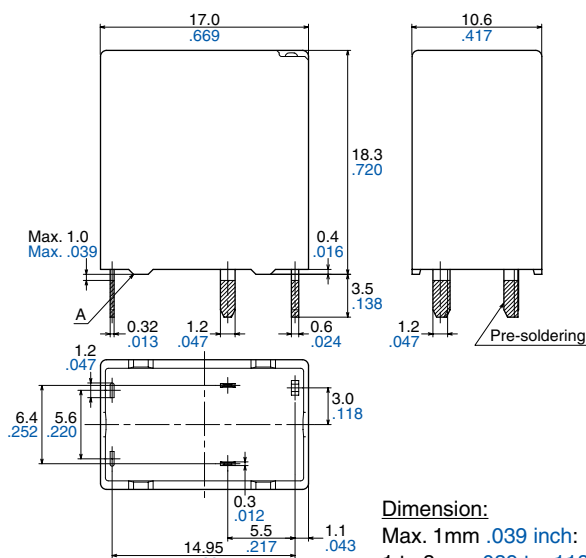

Dimension:	General tolerance
Max. 1mm .039 inch:	$\pm 0.1 \pm 0.04$
1 to 3mm .039 to .118 inch:	$\pm 0.2 \pm 0.08$
Min. 3mm .118 inch:	$\pm 0.3 \pm 0.12$

PC board pattern (Bottom view)

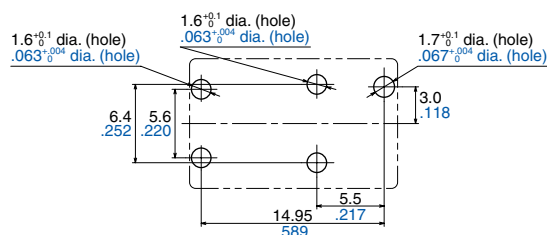

Tolerance: $\pm 0.1 \pm 0.04$

Schematic (Bottom view)

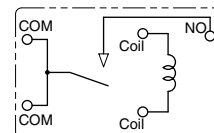

* Dimensions (thickness and width) of terminal specified in this catalog is measured before pre-soldering. Intervals between terminals is measured at A surface level.

NOTES

1. Coil operating power

Pure DC current should be applied to the coil. The wave form should be rectangular. If it includes ripple, the ripple factor should be less than 5%. However, check it with the actual circuit since the characteristics may be slightly different.

2. Coil applied voltage

To ensure proper operation, the voltage applied to the coil should be the rated operating voltage of the coil. Also, be aware that the pick-up and drop-out voltages will fluctuate depending on the ambient temperature and operating conditions.

3. Cycle lifetime

Check this with the real device as it is affected by coil driving circuit, load type, activation frequency, activation phase, ambient conditions and other factors.

4. Soldering

When soldering the relays, ensure conformance with the conditions listed below.

1) Automatic soldering

- Preheating: less than 100°C 212°F (solder target surface of PC board) for less than 120 sec
- Soldering: less than 260°C 500°F (solder temperature) for less than 5 sec (soldering time)

2) Manual soldering

- Soldering tip temperature: less than 280 to 300°C 536 to 572°F
- Soldering iron: 30 W to 60 W
- Soldering time: less than 5 sec

5. Usage, transport and storage conditions

1) Ambient temperature, humidity, and atmospheric pressure during usage, transport, and storage of the relay:

- (1) Temperature: -40 to +110°C -40 to +230°F
 - (2) Humidity: 2 to 85% RH (Avoid freezing and condensation.)
 - (3) Atmospheric pressure: 86 to 106 kPa
- The humidity range varies with the temperature. Use within the range indicated in the graph below. (Temperature and humidity range for usage, transport, and storage)

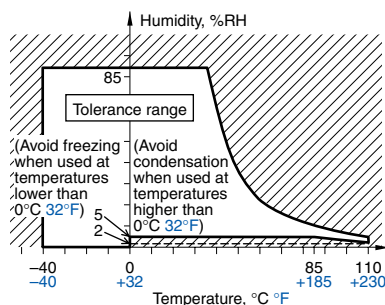

2) Condensation

Condensation forms when there is a sudden change in temperature under high temperature and high humidity conditions. Condensation will cause deterioration of the relay insulation.

3) Freezing

Condensation or other moisture may freeze on the relay when the temperatures is lower than 0°C 32°F. This causes problems such as sticking of movable parts or operational time lags.

4) Low temperature, low humidity environments

The plastic becomes brittle if the relay is exposed to a low temperature, low humidity environment for long periods of time.

6. Others

If the relay has been dropped, the appearance and characteristics should always be checked before use.